

GNExCP6B-PB, GNExCP6C-PB & GNExCP6D-PB Manual Call Point – Push Button With Resistor Modules For use in Flammable Gas and Combustible Dust Atmospheres.

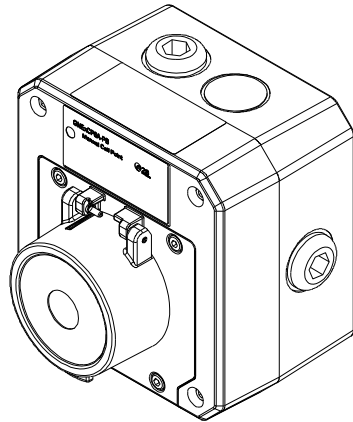

1) Introduction

The GNExCP6B-PB/ GNExCP6C-PB/ GNExCP6D-PB is a push button manual call point which is certified to the European and International Gas and Dust standards. The unit meets the requirements of the ATEX directive 2014/34/EU and IECEx scheme.

The call point can be used in hazardous areas where potentially flammable gas and dust atmospheres may be present.

2) Ratings & Markings

All units have a rating label, which carries the following important information: -

Unit Type No.:

GNExCP6B-PB Manual Call Point
GNExCP6C-PB Manual Call Point
GNExCP6D-PB Manual Call Point

Input Voltages:
48VDC nominal 56VDC Max 0.75A Max
24VDC nominal 28VDC Max 5.0A Max Resistive
Load; 3.0A Inductive Load
12VDC nominal 15VDC Max 5.0A Max
6VDC nominal 9VDC Max 5.0A Max

Code:	GNExCP6B-PB	GNExCP6C-PB
Ex db eb mb IIC T4 Gb	Ex db eb mb IIC T4 Gb	Ex db eb mb IIC T4 Gb
Ex tb IIIC T80°C Db	Ex tb IIIC T80°C Db	Ex tb IIIC T75°C Db
IP66	IP66	IP66
-40°C ≤ Ta ≤ +50°C	-40°C ≤ Ta ≤ +50°C	-40°C ≤ Ta ≤ +65°C

GNExCP6D-PB
Ex db eb mb IIC T4 Gb
Ex tb IIIC T80°C Db
IP66
-40°C ≤ Ta ≤ +70°C

Certificate No.:
SIRA 09ATEX3286X
IECEx SIR 09.0121X

Epsilon x:  II 2GD

CE Marking
Notified body No.  2813

Year/Serial No. i.e. 20/1CP6BPB000001
Or 20/1CP6CPB000001
Or 20/1CP6DPB000001

**WARNING - DO NOT OPEN WHEN AN
EXPLOSIVE ATMOSPHERE MAY BE PRESENT,
ELECTROSTATIC HAZARD – CLEAN ONLY
WITH A DAMP CLOTH**

3) Type Approval Standards

The call point has an EC Type examination certificate issued by SIRA and have been approved to the following standards: -

EN60079-0:2018 / IEC60079-0:2017
EN60079-1:2014 / IEC60079-1:2014
EN60079-7:2015 / IEC60079-7:2017
EN60079-18:2015 / IEC60079-18:2014
EN60079-31:2014 / IEC60079-31:2013

The equipment is certified for use in ambient temperatures in the range:
GNExCP6B-PB -40°C to +50°C
GNExCP6C-PB -40°C to +65°C
GNExCP6D-PB -40°C to +70°C
and shall not be used outside this range.

4) Installation Requirements

Installation of this equipment shall only be carried out by suitably trained personnel in accordance with the applicable code of practice e.g. IEC 60079-14/EN 60079-14

Repair of this equipment shall only be carried out by the manufacturer or in accordance with the applicable code of practice e.g. IEC 60079-19/EN 60079-19.

The certification of this equipment relies on the following materials used in its construction:

Enclosure: GRP - Glass Reinforced Polyester

Through enclosure mechanism: Plastic Nylon Zytel Injection Moulded

Sealing of enclosure and mechanism: O-ring Acrylonitrile-Butadiene Rubber

Potting Compound of resistors where used: Epoxy Resin

If the equipment is likely to come into contact with aggressive substances, then it is the responsibility of the user to take suitable precautions that prevent it from being adversely affected, thus ensuring that the type of protection is not compromised.

"Aggressive substances" - e.g. acidic liquids, gases or solvents that may affect polymeric materials.

"Suitable precautions" - e.g. regular checks as part of routine inspections or establishing from the material's data sheet that it is resistant to specific chemicals.

Leads connected to the terminals shall be insulated for the appropriate voltage and this insulation shall extend to within 1mm of the metal of the terminal throat. They shall only be installed and wired with cable in an ambient temperature of -10°C to +80°C

All terminal screws, used or unused, shall be tightened down to between 0.5 Nm and 0.7 Nm Refer to certificates SIRA 09ATEX3286X and IECEx SIR 09.0121X for special conditions of safe use.

Under extreme conditions the unit may generate an ignition-capable level of electrostatic charges. The unit must not be installed in a location where it may be subjected to external conditions (such as high-pressure steam) which may cause a build-up of electrostatic charges on non-conducting surfaces. Cleaning of the unit must only be carried out with a damp cloth.

5) Call Point Location and Mounting

The location of the call point should enable ease of access for operation and testing. The unit should be mounted using the 4 off fixing holes which will accept up to M4 sized fixings.

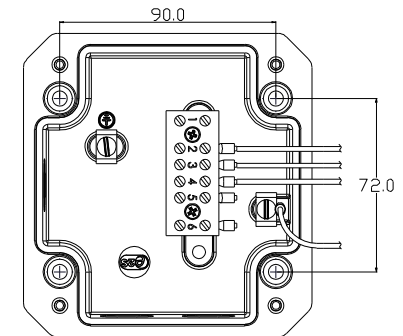

View of base unit showing fixing centres (in mm).

To gain access to the mounting holes in the base the front cover must be removed. This is achieved by removing the 4 off M4 cap head bolts holding on the cover.

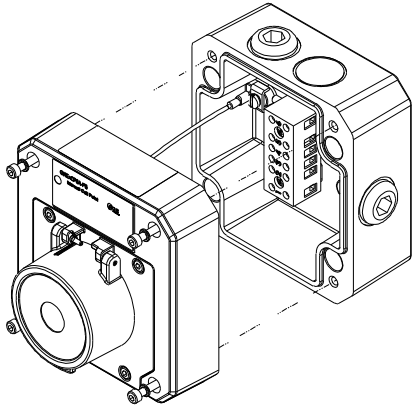

Once the screws are removed the cover will hang down out of the way to gain access to the Ex e terminal block, the internal earth terminal and mounting hole recesses.

6) Earthing

The unit has an internal earth terminal. It is recommended that a cable crimp lug is used on the earth wires. The internal earth wire is placed under an earth clamp which will stop the cable twisting. This is secured by an M4 screw and spring washer.

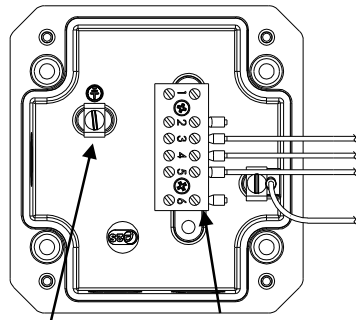

Internal Earth terminal Ex e terminal block

7) Cable connections

There are 3 off cable entries for M20x1.5 Ex e approved cable glands or stopping plugs with a minimum ingress protection of IP66

The unit can be wired in a number of different ways depending on the device combination selected.

GNExCP6B-PB / GNExCP6C-PB / GNExCP6D-PB
EOL (End of line) device; resistor – ExxxR / diode – ED1 / zener – ExxxZ
Series (In line) device; resistor – SxxxR / diode – SD1 / zener – SxxxZ / LED
Microswitch 1 = M/S 1
Microswitch 2 = M/S 2

The unit can be wired with a maximum of 2 module devices – see wiring diagrams.

Note: - The maximum voltage stated must not be exceeded, as the internal resistor modules are rated as compliant with Ex mb according to the units voltage

Please refer to wiring diagrams on sheets 4 & 5.

When wiring to Increased Safety terminal enclosures, you are only permitted to connect one wire into each way on the terminal block, unless a pair of wires are crimped into a suitable ferrule. Wire sizes allowable are 0.5sqmm to 4.0sqmm

The terminals are only permitted to be wired with cable in an ambient temperature range of between -10°C to 80°C. All terminal screws, used or unused, must be fully tightened down.

Leads connected to the terminals must be insulated for the appropriate voltage and this insulation must extend to within 1mm of the metal of the terminal throat.

8) Testing unit operation

The push button unit can be tested without the need to replace any element.

To test, lift the cover lift flap to reveal the push button. The button should be pressed into the body to activate the unit and place it into the operated condition.

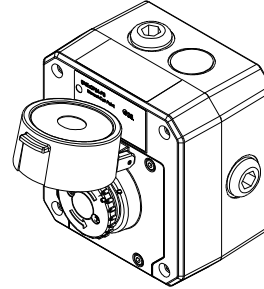

The call point switch will now change over its contacts to operate the alarm.

Once testing is complete the unit needs to be reset from the operated condition.

Rotate the push button anticlockwise by an angle of 55°, see guide alignment marks on the button and cover, shown below (1). The push button should pop back up to its original position. Ensure that the push button has also twisted back clockwise by 55° to its original position see guide marks on button and cover, shown below (2). The unit is now reset

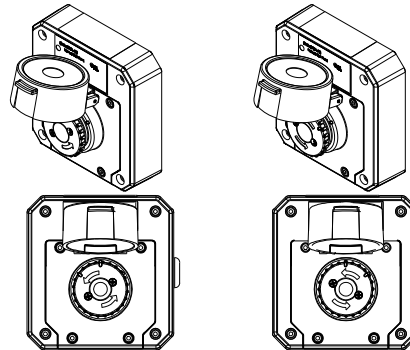

1. On operated unit twist push button anticlockwise 55° to reset

2. Button should pop up and twist back to original position

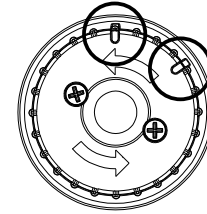

Note: use alignment marks circled to indicate the push buttons status/position

Unit currently shown as 'standby condition'

Resetting an operated unit is the same as resetting a tested unit.

9) SIL 2 Reliability Data

Reliability and Functional safety IEC/EN61508 which has been assessed and is considered suitable for use in low demand safety function:

- Random Hardware Failures and Systematic Failures (route 2H)
- As an unvoted item (i.e. hardware fault tolerance of 0) at SIL 2

The product was assessed against failure modes:

- Failure to close a contact when the call point is struck with specified force
- Failure to open a contact when the call point is struck with specified force
- Spurious output despite no input

Integrity in respect of failure to close	SIL 2
Total Failure rate	0.133 pmh
“hazardous” failure rate (revealed)	0 pmh
“hazardous” failure rate (unrevealed)	0.1 pmh
“safe” failure rate (revealed)	0.033 pmh
“safe” failure rate (unrevealed)	0
Diagnostic Coverage	99%
System type	A
Hardware Fault Tolerance	0
Safe Failure Fraction	>99%
PFD (hazardous failure)	1.25×10^{-3}
Proof Test Interval	Up to 1 year

Wiring Diagrams

Single Microswitch with EOL (End Of Line) Device

Resistor: - ExxxR
 Diode: - ED1
 Zener Diode: - ExxxZ

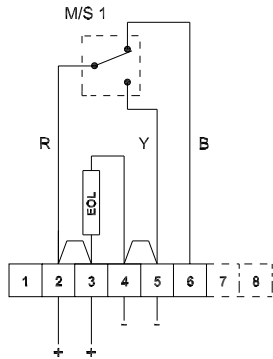
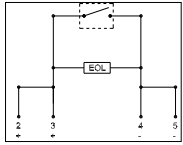

1A - Circuit shown in Unoperated condition
 Terminals +(2,3) & -(4,5) open
 Terminals +(2,3) & (6) closed

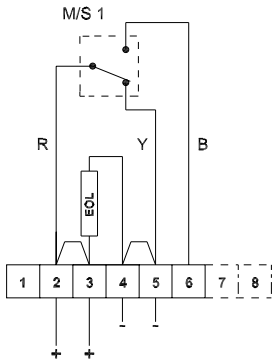

1B - Circuit shown in Operated condition (Button pressed In)
 Terminals +(2,3) & -(4,5) closed
 Terminals +(2,3) & (6) open

Single Microswitch with Series Device

Resistor: - SxxxR
 Diode: - SD1
 Zener Diode: - SxxxZ
 LED: - LED

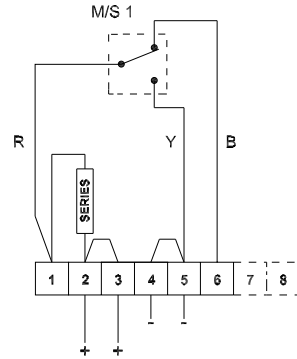
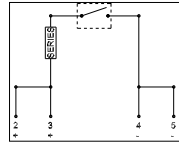

2A - Circuit shown in Unoperated condition
 Terminals +(2,3) & -(4,5) open
 Terminals +(2,3) & (6) closed

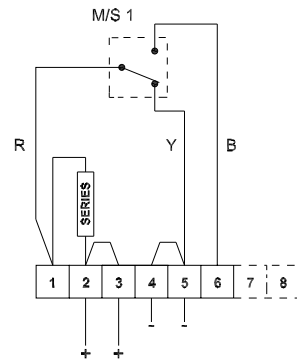

2B - Circuit shown in Operated condition (Button pressed In)
 Terminals +(2,3) & -(4,5) closed
 Terminals +(2,3) & (6) open

Single Microswitch with EOL & Series Device

Resistor: - EOL Series
 Diode: - ExxxR SxxxR
 Zener Diode: - ED1 SD1
 LED: - ExxxZ SxxxZ
 N/A LED

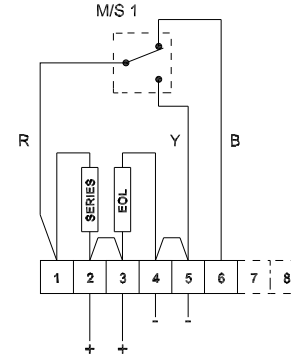
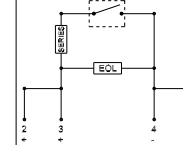

3A - Circuit shown in Unoperated condition
 Terminals +(2,3) & -(4,5) open
 Terminals +(2,3) & (6) closed

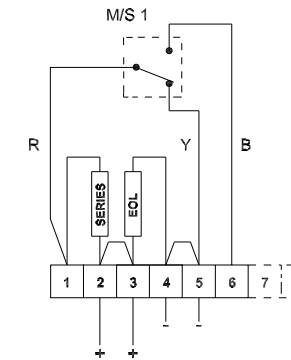

3B - Circuit shown in Operated condition (Button pressed In)
 Terminals +(2,3) & -(4,5) closed
 Terminals +(2,3) & (6) open

Single Microswitch with EOL & Series Device Wiring Option 2 -W2

Resistor: - EOL Series
 Diode: - ExxxR SxxxR
 Zener Diode: - ED1 SD1
 LED: - ExxxZ SxxxZ
 N/A LED

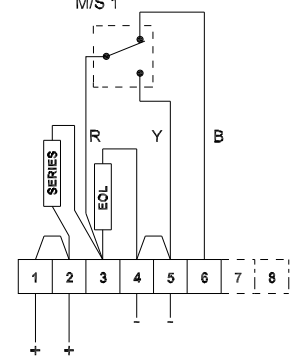
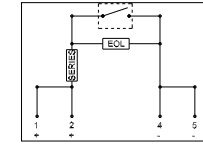

4A - Circuit shown in Unoperated condition
 Terminals +(1,2) & -(4,5) M/S 1 open
 Terminals +(1,2) & (6) M/S 1 closed

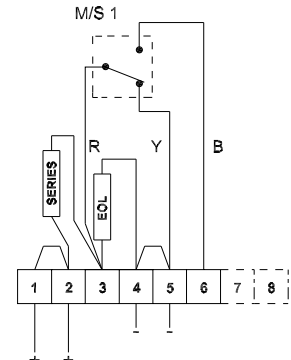

4B - Circuit shown in Operated condition (Button pressed In)
 Terminals +(1,2) & -(4,5) M/S 1 closed
 Terminals +(1,2) & (6) M/S 1 open

Dual Microswitch with EOL (End Of Line) Device/s

Resistor: - ExxxR
 Diode: - ED1
 Zener Diode: - ExxxZ

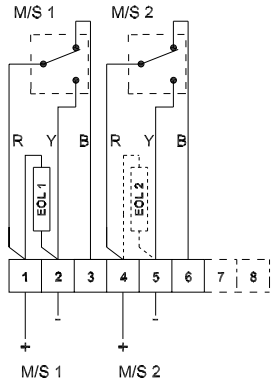
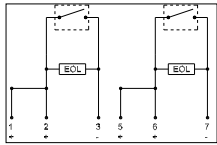

5A - Circuit shown in Unoperated condition (Glass Intact)
 Terminals + (1) & -(2) M/S 1 open and +(4) & -(5) M/S 2 open
 Terminals +(1) & (3) M/S 1 and +(4) & (6) M/S 2 closed

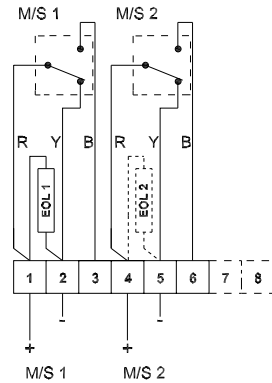

5B - Circuit shown in Operated condition (Glass Broken)
 Terminals + (1) & -(2) M/S 1 open and +(4) & -(5) M/S 2 closed
 Terminals +(1) & (3) M/S 1 and +(4) & (6) M/S 2 open

Single Microswitch with L.E.D., EOL & Series Device

Resistor: - ExxxR Series SxxxR
 Diode: - ED1 SD1
 Zener Diode: - ExxxZ SxxxZ
 LED: - N/A LED

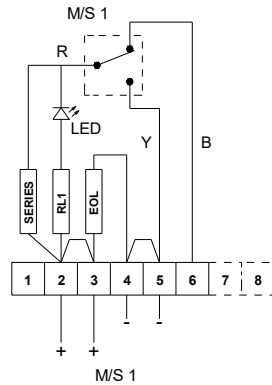
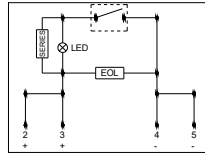

6A - Circuit shown in Unoperated condition (Glass Intact)
 Terminals +(2,3) & -(4,5) open
 Terminals +(2,3) & (6) closed

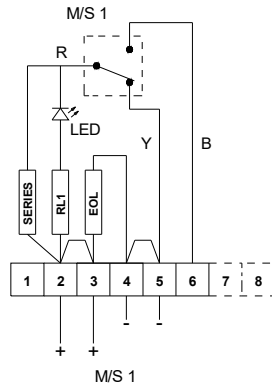

6B - Circuit shown in Operated condition (Glass Broken)
 Terminals +(2,3) & -(4,5) closed
 Terminals +(2,3) & (6) open

(DIN RAIL ONLY)

Dual Microswitch with Series Device/s

Resistor: - SxxxR
 Diode: - SD1
 Zener Diode: - SxxxZ
 LED: - LED

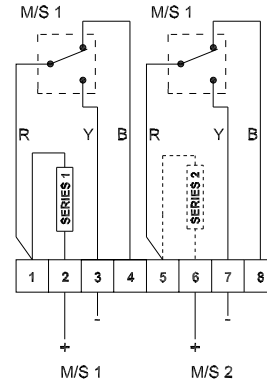
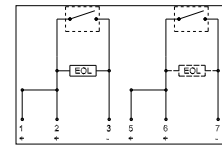

7A - Circuit shown in Unoperated condition (Glass Intact)
 Terminals +(2,3) & -(4,5) open
 Terminals +(2,3) & (6) closed

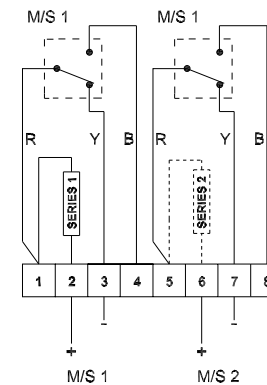

7B - Circuit shown in Operated condition (Glass Broken)
 Terminals +(2) & -(3) M/S 1 and +(6) & -(7) M/S 2 closed
 Terminals +(2) & (4) M/S 1 and +(6) & (8) M/S 2 open

(DIN RAIL ONLY)

Dual Microswitch with EOL & Series Device/s

Resistor: - ExxxR Series SxxxR
 Diode: - ED1 SD1
 Zener Diode: - ExxxZ SxxxZ
 LED: - N/A LED

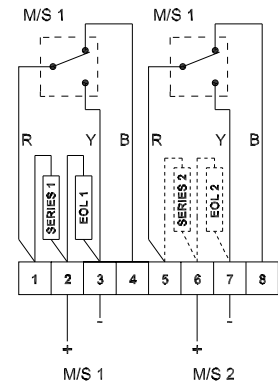
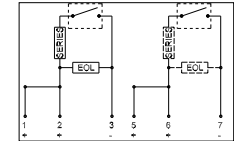

8A - Circuit shown in Unoperated condition (Glass Intact)
 Terminals +(2) & -(3) M/S 1 and +(6) & -(7) M/S 2 open
 Terminals +(2) & (4) M/S 1 and +(6) & (8) M/S 2 closed

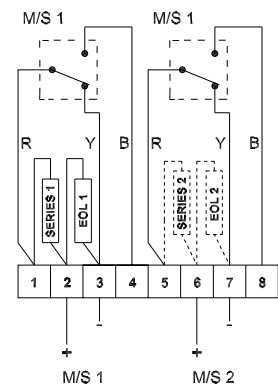

8B - Circuit shown in Operated condition (Glass Broken)
 Terminals +(2) & -(3) M/S 1 and +(6) & -(7) M/S 2 closed
 Terminals +(2) & (4) M/S 1 and +(6) & (8) M/S 2 open